

PMV-20/A

1/4 "–5/2, 3/2 High Flow Pilot Valve

- \* Streamlined Construction
- \* Contoured dynamic seals ensures longer life
- \* Higher Flow Capacities
- Facility of gang manifolding with 5/2 valves

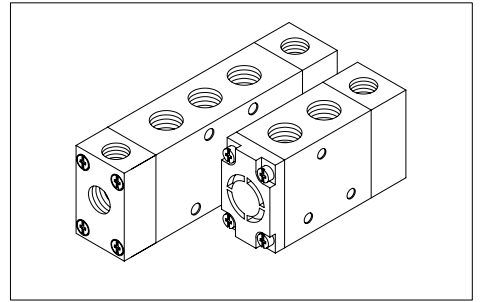

PART LIST- 5/2 WAY VALVES

NO.	DESCRIPTION	QTY.	
		Single Pilot	Double Pilot
1	Valve body	1	1
2	Spool	1	1
3	Spring housing	1	-
4	Spring	1	-
5	Spool Seal	6	6
6	Gasket	1	-
* 7	Base plate	1	1
* 8	Sub base O rings	5	5
9	Pilot Housing	1	2
10	Plug for Pilot Housing	1	2
11	Piston O ring	1	2

Seal kit consists of items (2+ 5), 6, 8,& 11

\* (For Sub base valve only)

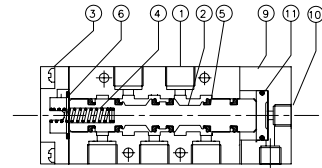

5/2 Single Pilot High Flow Valve

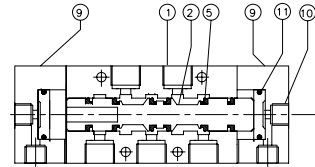

5/2 Double Pilot High Flow Valve

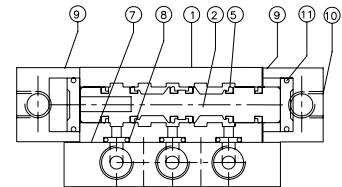

5/2 Double Pilot High Flow Valve (Sub base)

PART LIST- 3/2 WAY VALVES

NO.	DESCRIPTION	QTY.	
		Single Pilot	Double Pilot
1	Valve body	1	1
2	Spool	1	1
3	Spring housing	1	-
4	Spring	1	-
5	Spool Seal	4	4
6	Gasket	1	-
7	Pilot Housing	1	2
8	Plug for Pilot Housing	1	2
9	Piston O ring	1	2

Seal kit consists of items (2+ 5), 6 & 9

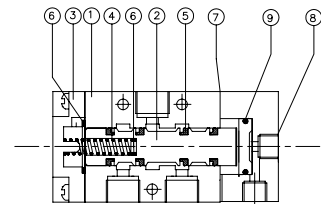

3/2 Single Pilot High Flow Valve

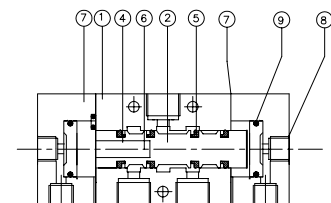

3/2 Double Pilot High Flow Valve

## G 1/4-5/2 & 3/2 SINGLE PILOT HIGH FLOW VALVE

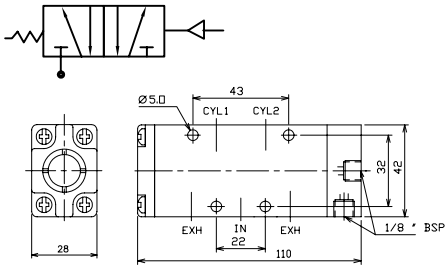

5/2 Single Pilot High Flow Valve

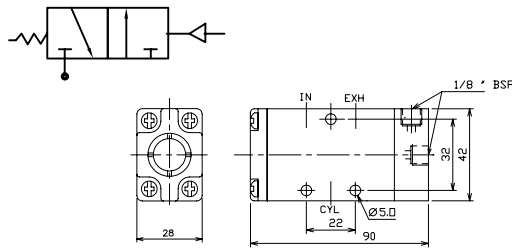

3/2 Single Pilot High Flow Valve

Type	Side ported Valve	Valve with sub base plate
5/2 Single Pilot Valve	43004 PS	43204 PS
3/2 Single Pilot Valve	43003 PS	---
Type	Seal-kit for Side ported Valve	Seal-kit for Sub base Valve
5/2 Single Pilot Valve	SK 43004	SK 43204
3/2 Single Pilot Valve	SK 43003	---

### SPECIFICATION

Medium	Compressed Air, Filtered
Design	Spool Type With Air Spring Return
Working Pressure	1.8 – 10 kg/sq.cm.
Ambient/Fluid Temp.	-10° C to 55° C
Cv(Nominal Flow)	1.3 ( 1300 Lit/min)
Response Time at 5 Bar	ON Time:-10 m.s. OFF Time:- 35 m.s.
Materials	Body,Spool :- Aluminium Seals:- NBR

## G 1/4-5/2 & 3/2 DOUBLE PILOT HIGH FLOW VALVE

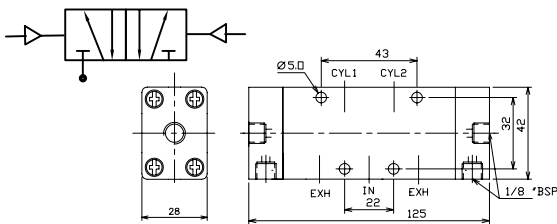

5/2 Double Pilot High Flow Valve

Type	Side ported Valve	Valve with sub base plate
5/2 Double Pilot Valve	43004 PP	43204 PP
3/2 Double Pilot Valve	43003 PP	---
Type	Seal-kit for Side ported Valve	Seal-kit for Sub base Valve
5/2 Double Pilot Valve	SK 43004	SK 43204
3/2 Double Pilot Valve	SK 43003	---

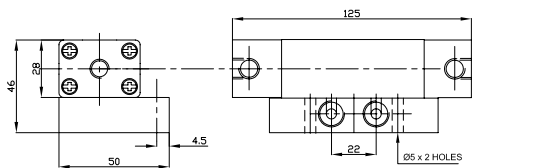

5/2 Double Pilot High Flow Valve (Sub base)

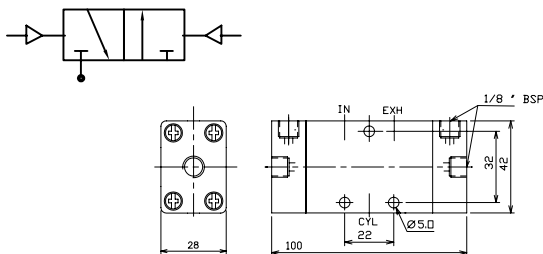

3/2 Double Pilot High Flow Valve

### SPECIFICATION

Medium	Compressed Air, Filtered
Design	Spool Type With Air Spring Return
Working Pressure	1.8 – 10 kg/sq.cm.
Ambient/Fluid Temp.	-10° C to 55° C
Cv(Nominal Flow)	1.3 ( 1300 Lit/min)
Response Time at 5 Bar	ON Time:-10 m.s. OFF Time:- 35 m.s.
Materials	Body,Spool :- Aluminium Seals:- NBR